

SYSMAC C1000H/C2000H

SYSMAC C60H

Smallest PLC in the SYSMAC C Series

Programmable Controllers

# SYSMAC CPM1A

SYSMAC C200H  
/C200HS

SYSMAC C20H  
/C28H  
/C40H

V1-type CPU Units  
Now Available

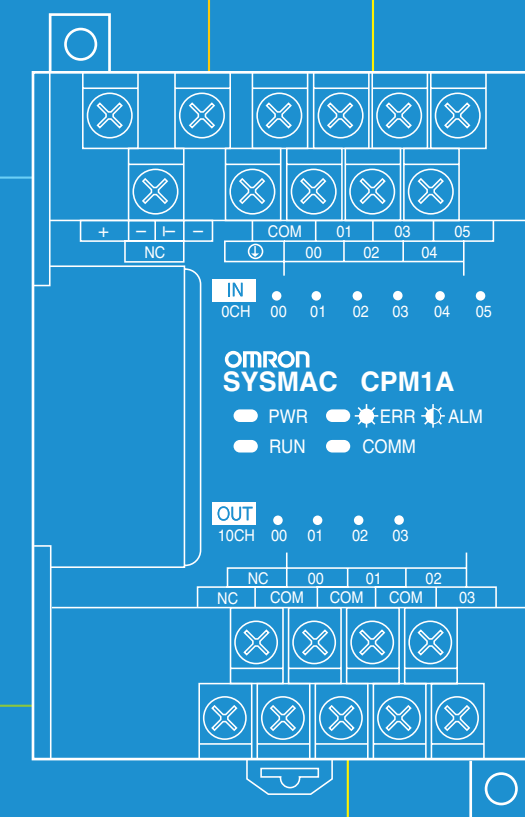

SYSMAC CPM1A

SYSMAC C20P/C28P/C40P

Transistor output models are new additions to the CPM1A Series.

**OMRON Corporation**

FA Systems Division H.Q.  
66 Matsumoto  
Mishima-city, Shizuoka 411-8511  
Japan  
Tel: (81)55-977-9181  
Fax: (81)55-977-9045

**Regional Headquarters**

**OMRON EUROPE B.V.**  
Wegalaan 67-69, NL-2132 JD Hoofddorp  
The Netherlands  
Tel: (31)2356-81-300/Fax: (31)2356-81-388

**OMRON ELECTRONICS LLC**  
1 East Commerce Drive, Schaumburg, IL 60173  
U.S.A.  
Tel: (1)847-843-7900/Fax: (1)847-843-8568

**OMRON ASIA PACIFIC PTE. LTD.**  
83 Clemenceau Avenue,  
#11-01, UE Square,  
Singapore 239920  
Tel: (65)6835-3011/Fax: (65)6835-2711

**Authorized Distributor:**

Note: Specifications subject to change without notice.

Cat. No. P039-E1-11  
Printed in Japan  
0404-1M

# SYSMAC

## CPM1A

## Programmable Controllers

### The Smallest PLC in the SYSMAC Family Shows Just How Far Downsizing Can Go

The SYSMAC C Series began developing a wide range of Programmable Controllers to meet factory automation needs in 1973. And now the CPM1A joins the C Series history as a small PLC that has all the power of previous small PLCs but requires far less mounting space. The CPM1A also provides flexibility in I/O capacity ranging from 10 to 100 I/O points. The CPM1A can replace relay control, help distribute I/O, work as a miniature machine controller or sensor controller, or fill many other vital roles in factory automation.

The 10-point CPU is approximately the size of a PC Card.

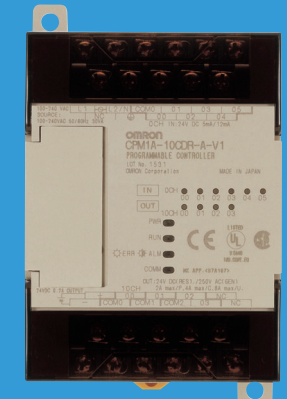
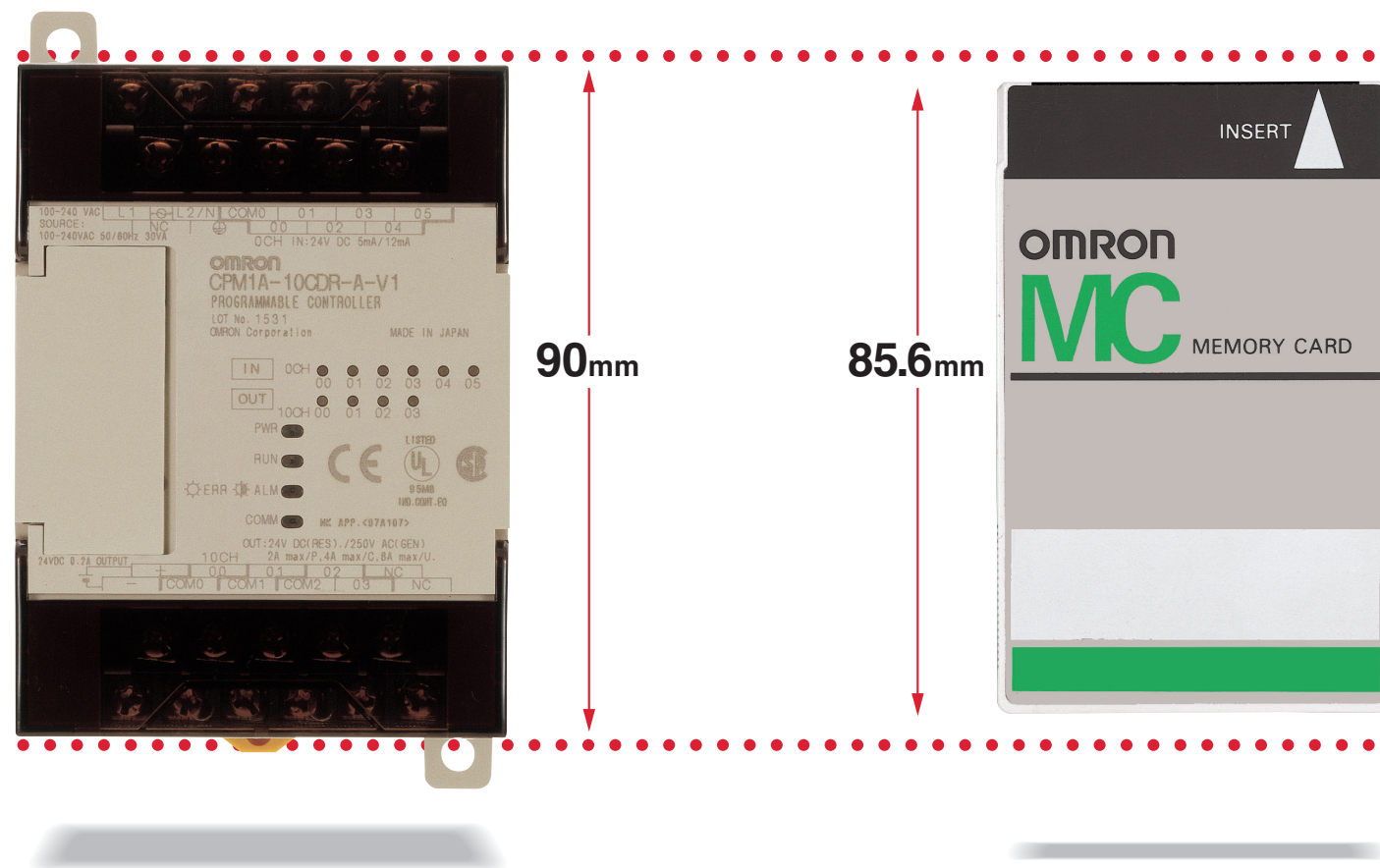

## Contents

<b>System Configuration</b>	<b>6-7</b>
CPM1A Line-up	6
CPM1A System Configuration	7
External Dimensions	7
<b>Specifications</b>	<b>8-15</b>
General Specifications	8
Power Consumption for DC Models	8
Performance Specifications	9
I/O Specifications	10
CPM1A-DRT21 DeviceNet I/O Link Unit	13
Temperature Sensor Units	13
Communications Adapter	
Specifications CPM1-CIF01/CIF11	14
CPM2C-PA201 AC Power Supply Unit	15
<b>Functions</b>	<b>16-21</b>
Input Interrupts	16
Quick-response Inputs	17
High-speed Counter	17
Interval Timer Interrupts	18
Analog Setting	18
Pulse Output Function	19
Communications	20
<b>Programming Instructions</b>	<b>22-25</b>
Peripheral Devices	26
<b>Standard Models</b>	<b>27-29</b>
Expansion Memory Unit	30

This catalog contains information necessary to select models.

It does not include precautionary information. Please refer to the CPM1A manuals for the required information.

# Flexible Control and Plenty of Power in the Minimum Body Size

The CPM1A can be easily built into a wide array of machines or control panels. For example, you can use the CPM1A to control a few more I/O points on existing lines without having to install a new control panel. Just install the CPM1A in available space to control only the required number of I/O. The CPM1A was born to reduce waste in the factories by effectively using valuable space.

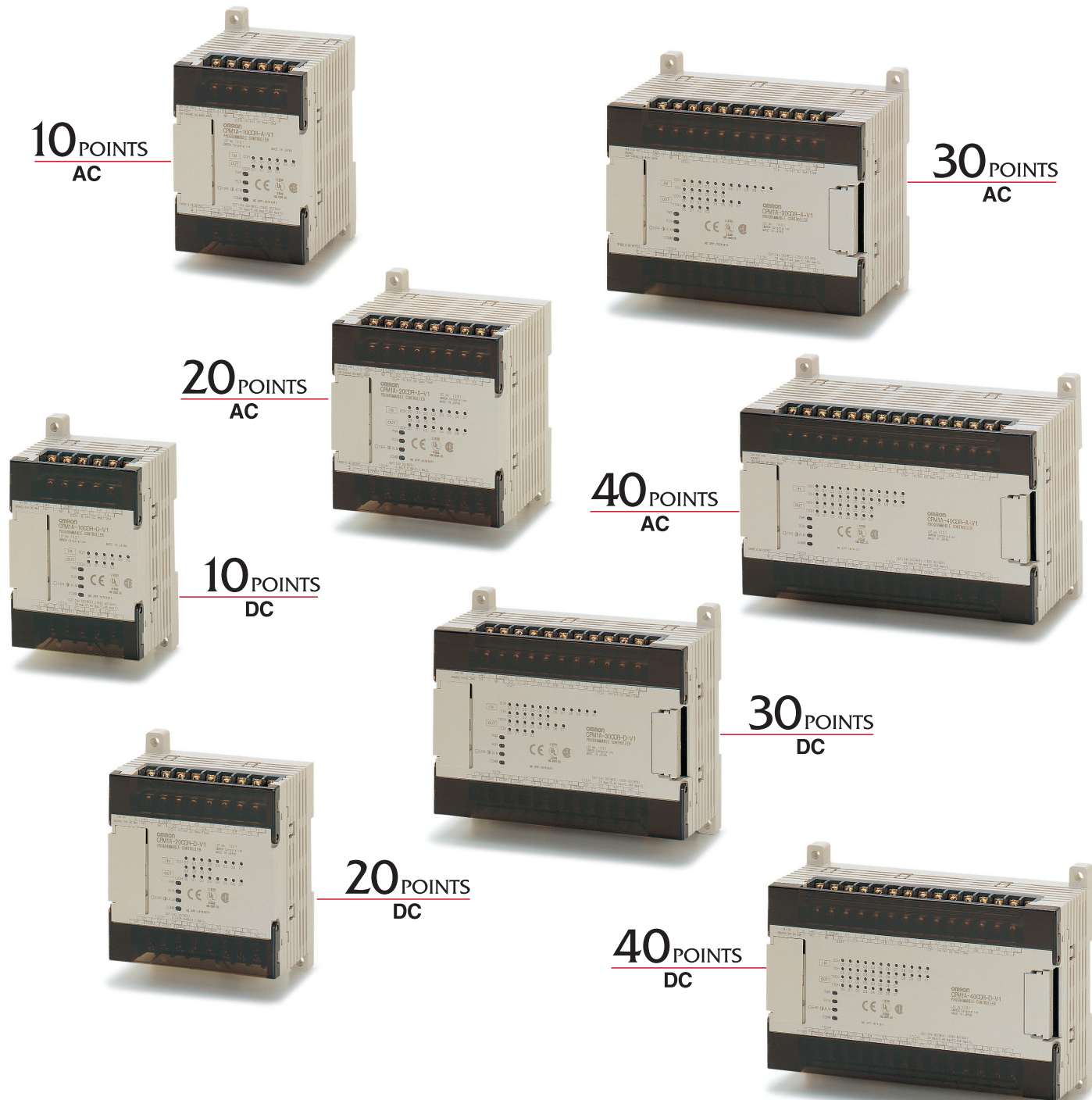

## Select Units to Control from 10 to 100 I/O Points

CPUs are available with from 10 to 40 I/O points and, in combination with Expansion I/O Units, can be used to control a total of from 10 to 100 points.

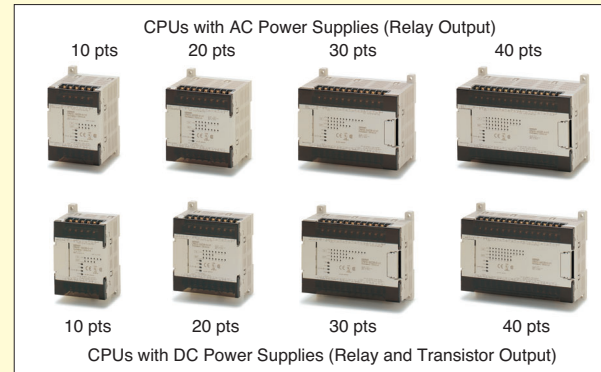

Only 30- and 40-point CPUs support Expansion I/O Units. Up to three Expansion I/O Units can be connected.

CPM1A-20EDR1/-20EDT(1)  
CPM1A-8ED/-8ER/8ET(1)

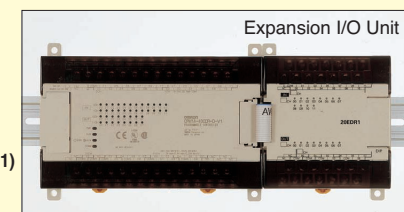

# SYSMAC CPM1A

## Easy Connection to Programmable Terminals

An optional Communications Adapter supports Host Link or NT Link connections for high-speed communications with OMRON PTs.

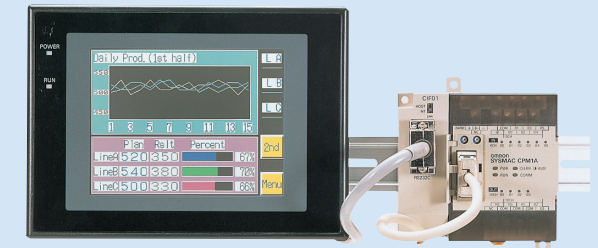

## Windows-based Support Software

The Windows-based CX-Programmer Support Software reduces software development time and provides powerful monitoring and debugging functions. Other Windows applications can be used and the programming environment has been greatly improved.

### Reduce Software Development Time with Windows-based CX-Programmer

CX-Programmer's many monitoring and debugging functions provide powerful support for multiple program development.

- User-friendly operations
- Powerful display/monitoring functions
- Powerful debugging functions
- Remote programming and monitoring
- Maintenance functions
- Data compatibility with Windows applications

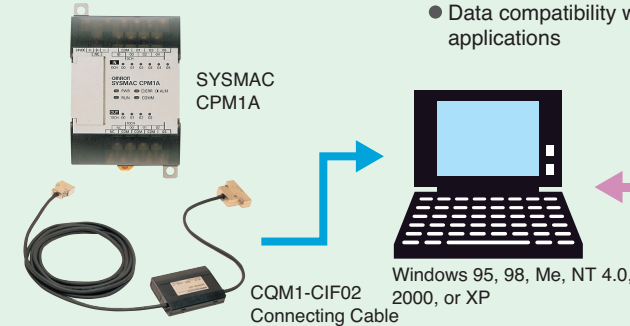

### Programming Consoles

Hand-held Programming Consoles are ideal for onsite startup and adjustments.

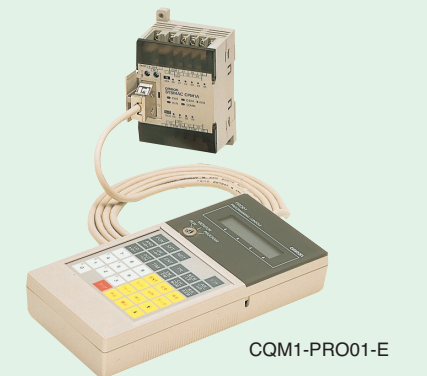

## Full Functionality in a Compact Body

Plenty of programming capacity and a large instruction set handle even complex control operations.

User memory: 2,048 words	Basic instructions: 14
Data memory: 1,024 words	Special instructions: 79
Timers/Counters: 128	Analog adjustments: 2

## High-speed Execution

LOAD instructions execute at 1.7  $\mu$ s and MOVE instructions execute at 16.3  $\mu$ s for fast program execution. High-speed scanning is thus possible even with large programs. Interrupt inputs and quick-response inputs can be used to handle high-speed pulses that are too fast for the scan time.

# System Configuration

## ■ CPM1A Line-up

- CPU with AC Power Supply** • DC input • RY output / TR output  
**CPU with DC Power Supply** • DC input • RY output / TR output

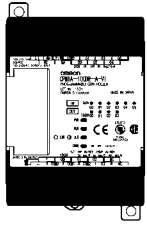

10 I/O points  
(Expansion not possible)

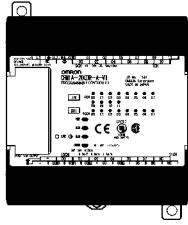

20 I/O points  
(Expansion not possible)

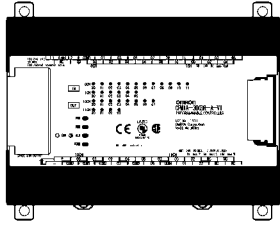

30 I/O points

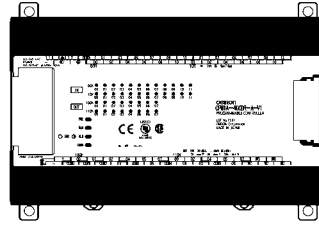

40 I/O points

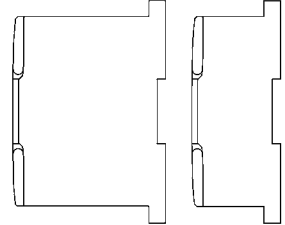

### Expansion I/O Unit

- DC input
- RY output / TR output

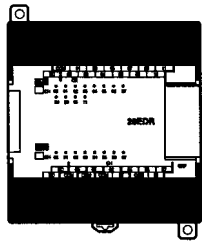

20 I/O points

### Expansion I/O Unit

- DC input
- RY output / TR output

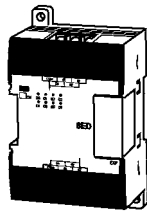

### DeviceNet I/O Link Unit

CPM1A-DRT21

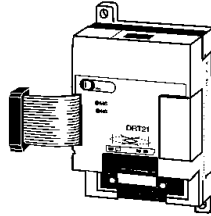

### CompoBus/S I/O Link Unit

CPM1A-SRT21

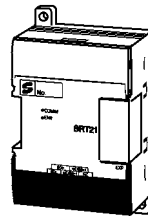

### Analog I/O Unit

CPM1A-MAD01  
-MAD11

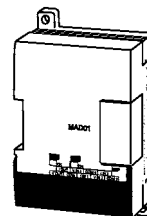

### Temperature Sensor Units

CPM1A-TS001  
TS002  
TS101  
TS102

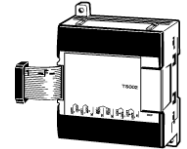

### RS-232C Adapter

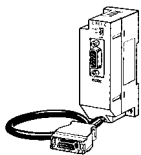

CPM1-CIF01

### RS-422 Adapter

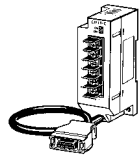

CPM1-CIF11

# System Configuration

## ■ CPM1A System Configuration

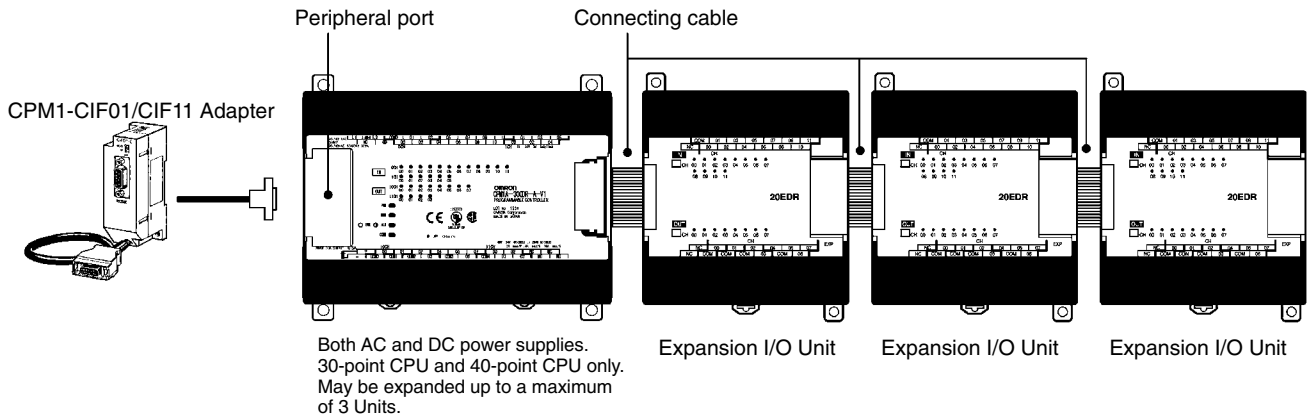

### Connection Groups for Expansion Units

Group 1 (G1)	Group 2 (G2)
Expansion I/O Units, Analog I/O Unit, CompoBus/S I/O Link Unit DeviceNet I/O Link Unit CPM1A-TS001/101	CPM1A-TS002/102

In addition to the CPU Unit, Expansion Units from the groups indicated in the above table can be combined as shown below.

### Possible Expansion Unit Combinations

Expansion Unit 1	Expansion Unit 2	Expansion Unit 3
G1	G1	G1
G2	G1	---

- Note:**
1. Expansion Units 1, 2, and 3 can be mounted in any order.
  2. Only one Expansion Unit can be mounted if an NT-AL001 is connected to the RS-232C port.

## ■ External Dimensions

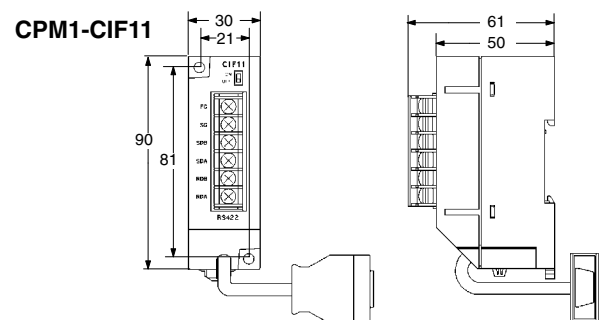
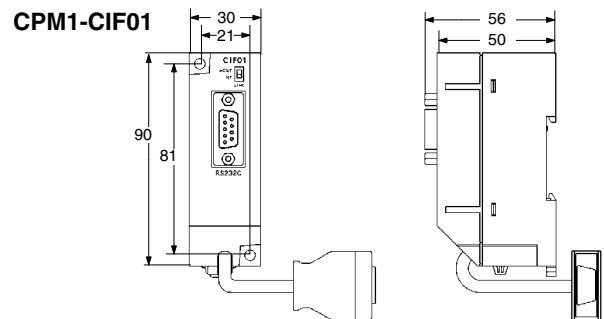
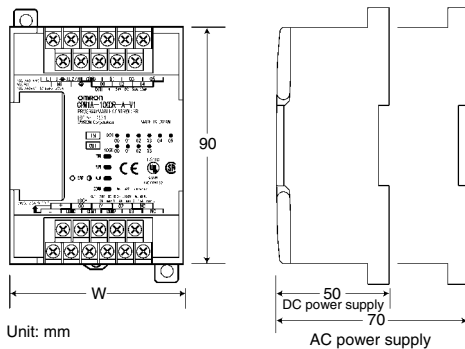

Model	W (mm)
CPM1A-10CD□-A-V1/D-V1	66
CPM1A-20CD□-A-V1/D-V1	86
CPM1A-30CD□-A-V1/D-V1	130
CPM1A-40CD□-A-V1/D-V1	150
CPM1A-20ED□	86 (depth: 50 mm)
CPM1A-8E□/SRT21	66 (depth: 50 mm)
CPM1A-MAD01	66 (depth: 50 mm)
CPM1A-TS□□/MAD11	86 (depth: 50 mm)
CPM1A-DRT21	60 (depth: 50 mm)

# Specifications

## ■ General Specifications

Item		10-point I/O	20-point I/O	30-point I/O	40-point I/O
Power supply voltage/ frequency	AC power supply	100 to 240 VAC, 50/60 Hz			
	DC power supply	24 VDC			
Operating voltage range	AC power supply	85 to 264 VAC			
	DC power supply	20.4 to 26.4 VDC			
Power consumption	AC power supply	30 VAC max.		60 VAC max.	
	DC power supply	(See below.)			
Inrush current		30 A max.		60 A max.	
External power supply (AC only)	Power supply voltage	24 VDC			
	Power supply output capacity	200 mA		300 mA	
Insulation resistance		20 MΩ min. at 500 VDC between the AC terminals and the protective earth terminal.			
Dielectric strength		2,300 VAC at 50/60 Hz for one minute with a leakage current of 10 mA max. between all the external AC terminals and the protective earth terminal.			
Noise resistance		Conforms to IEC61000-4-4, 2 kV (power lines)			
Vibration resistance		10 to 57 Hz with an amplitude of 0.075 mm, and 57 to 150 Hz with an acceleration of 9.8 m/s <sup>2</sup> in the X, Y, and Z directions for 80 minutes each (i.e. swept for 8 minutes, 10 times).			
Shock resistance		147 m/s <sup>2</sup> in the X, Y and Z directions 3 times each.			
Ambient temperature (operating)		0° to 55°C			
Ambient humidity (operating)		10% to 90% (no condensation)			
Ambient environment (operating)		With no corrosive gas			
Ambient temperature (storage)		-20° to 75°C			
Terminal screw size		M3			
Power supply holding time		10 ms min. for AC models, and 2 ms min. for DC models			
Weight		AC model: 400 g max. DC model: 300 g max.	AC model: 500 g max. DC model: 400 g max.	AC model: 600 g max. DC model: 500 g max.	AC model: 700 g max. DC model: 600 g max.

**Note:** The specifications of the Expansion I/O Unit are the same as for the CPU except that the power is supplied from the CPU and the weight is 300 g.

## ■ Power Consumption for DC Models

The power consumptions for CPM1A CPU Units and Expansion I/O Units are given in the tables below. Use them to calculate the required power supply capacity. The CPM2C-PA201 provides a 15-W power supply. Any surplus power that is beyond that required for the PLC itself can be used for servicing devices such as sensors.

CPM1A CPU Unit	Power consumption	Expansion
CPM1A-10CDR-D-V1	3.5 W	Not supported
CPM1A-20CDR-D-V1	4.5 W	Not supported
CPM1A-30CDR-D-V1	5.5 W	Supported
CPM1A-40CDR-D-V1	6.5 W	Supported
CPM1A-10CDT-V1/T1-D-V1	3 W	Not supported
CPM1A-20CDT-V1/T1-D-V1	3.5 W	Not supported
CPM1A-30CDT-V1/T1-D-V1	4 W	Supported
CPM1A-40CDT-V1/T1-D-V1	4.5 W	Supported

CPM1A Expansion I/O Unit	Power consumption
CPM1A-20EDR1	2.5 W
CPM1A-20EDT/T1	1.5 W
CPM1A-8ED	1 W
CPM1A-8ER	2 W
CPM1A-8ET/T1	1 W
CPM1A-SRT21/DRT21	1 W
CPM1A-MAD01/MAD11	3.5 W
CPM1A-TS001/TS101	3 W
CPM1A-TS002/TS102	3 W

**Note:** The power consumption for CPU Units includes the power consumption of Programming Consoles and Units such as RS-232C Adapters

# Specifications

## ■ Performance Specifications

Item		10-point I/O	20-point I/O	30-point I/O	40-point I/O
Control method		Stored program method			
I/O control method		Combination of the cyclic scan and immediate refresh processing methods.			
Programming language		Ladder diagram			
Instruction word		1 step per instruction, 1 to 5 words per instruction			
Types of instructions	Basic instructions	14 types			
	Special instructions	79 types, 139 instructions			
Instruction execution time	Basic instructions	0.72 to 16.2 $\mu$ s			
	Special instructions	MOV instruction = 16.3 $\mu$ s			
Program capacity		2,048 words			
Maximum I/O points	CPU only	10 points (6 input/4 output points)	20 points (12 input/8 output points)	30 points (18 input/12 output points)	40 points (24 input/16 output points)
	With Expansion I/O Unit	---	---	90 points (54 input/36 output points)	100 points (60 input/40 output points)
Input bits		00000 to 00915 (Words 0 to 9)			
Output bits		01000 to 01915 (Words 10 to 19)			
Work bits (IR Area)		512: IR 20000 to IR 23115 (IR 200 to IR 231)			
Special bits (SR Area)		384: SR 23200 to SR 25515 (SR 232 to SR 255)			
Temporary bits (TR Area)		8: TR 0 to TR 7			
Holding bits (HR Area)		320: HR 0000 to HR 1915 (HR 00 to HR 19)			
Auxiliary bits (AR Area)		256: AR 0000 to AR 1515 (AR 00 to AR 15)			
Link bits (LR Area)		256: LR 0000 to LR 1515 (LR 00 to LR 15)			
Timers/Counters		128: TIM/CNT 000 to 127 100-ms timer: TIM 000 to TIM 127 10-ms timer: TIM 000 to TIM 127 Decremental counter, reversible counter			
Data memory	Read/Write	1,024 words (DM 0000 to DM 1023)			
	Read only	512 words (DM 6144 to DM 6655)			
Interrupt processing: External interrupt		2 points (Response time of 0.3 ms max.)	4 points (Response time of 0.3 ms max.)		
Memory protection		Maintains the contents of the HR, AR, Counter and Data Memory Areas.			
Memory backup		Flash memory: User program, data memory (Read only) (Non-battery powered storage) Super capacitor: Data memory (Read/Write), holding bits, auxiliary memory bits, counter (20-day storage at an ambient temperature of 25°C)			
Self-diagnostic function		CPU error (watchdog timer), memory errors, I/O bus errors			
Program check		No END instruction programming errors (constantly checked during operation)			
Pulse output		1 point: 2 kHz			
High-speed counter		1 point: Single phase at 5 kHz or two-phase at 2.5 kHz (linear counting method) Incremental mode: 0 to 65535 (16-bit) Decremental mode: -32767 to 32767 (16-bit)  1 point: Single phase at 5 kHz or two-phase at 2.5 kHz (linear counting method) Incremental mode: 0 to 65535 (16-bit) Decremental mode: -32767 to 32767 (16-bit)			
Quick-response inputs		Together with the external interrupt input (minimum pulse width of 0.2 ms)			
Input time constant		Can be set at 1 ms, 2 ms, 4 ms, 8 ms, 16 ms, 32 ms, 64 ms, or 128 ms.			
Analog settings		2 points: (0 to 200)			

**Note:** Bits that are not used for the I/O bits can be used as work bits.

# Specifications

## ■ I/O Specifications

### Input Circuit

#### CPU

Item	Specifications	Circuit
Input voltage	24 VDC +10%/−15%	<p><b>Note</b> The polarity of the input power supply can be either positive or negative. Resistance values in parentheses are for inputs IN00000 to IN00002.</p>
Input impedance	IN00000 to IN00002: 2 kΩ Others: 4.7 kΩ	
Input current (typical)	IN00000 to IN00002: 12 mA Others: 5 mA	
ON voltage	14.4 VDC min.	
OFF voltage	5.0 VDC max.	
ON delay (see note 1)	1 to 128 ms max. (default: 8 ms) (see note 1)	
OFF delay (see note 1)	1 to 128 ms max. (default: 8 ms) (see note 1)	

**Note:** 1. The actual ON/OFF delay includes an input constant of 1, 2, 4, 8, 16, 32, 64, or 128 ms (default: 8 ms).

2. The delays for IN00000 to IN00002 are as follows when used for the high-speed counter.

Input	Increment mode	Differential phase mode
IN00000 (A-phase)	5 kHz	2.5 kHz
IN00001 (B-phase)	Normal input	
IN00002 (Z-phase)	ON: 100 μs max. OFF: 500 μs max.	

3. The delays for IN00003 to IN00006 are as follows when used for the high-speed counter.

Delay	0.3 ms max. (From the time of input ON until the interrupt subroutine is executed.)
-------	---

### Expansion I/O Unit

Item	Specifications	Circuit
Input voltage	24 VDC, +10%/−15%	<p><b>Note</b> The polarity of the input power supply can be either positive or negative.</p>
Input impedance	4.7 kΩ	
Input current (typical)	5 mA	
ON voltage	14.4 VDC min.	
OFF voltage	5.0 VDC max.	
ON delay	1 to 128 ms max. (default: 8 ms) (see note)	
OFF delay	1 to 128 ms max. (default: 8 ms) (see note)	

**Note:** The actual ON/OFF delay includes an input constant of 1, 2, 4, 8, 16, 32, 64, or 128 ms (default: 8 ms).



# Specifications

## Output Circuit

### CPU and Expansion I/O Unit

#### Relay Output

Item		Specifications	Circuit	
Maximum switching capacity		250 VAC/2 A (cos $\phi = 1$ ) 24 VDC/2 A (4 A/common)	<p>Maximum 250 VAC: 2 A 24 VDC: 2 A</p>	
Minimum switching capacity		5 VDC, 10 mA		
Relay service life	Electrical	Resistance load		150,000 times (at 24 VDC)
		Inductive load		100,000 times (at 220 VAC, cos $\phi=0.4$ )
	Mechanical			20 million times
ON delay		15 ms max.		
OFF delay		15 ms max.		

#### Transistor Output (Sink Type/Source Type) (CPU/Expansion I/O Unit)

Item		Specifications	Circuit
Maximum switching capacity		24 VDC $+10\%/-15\%$ , 300 mA (see note 1)	
Leakage current		0.1 mA max.	
Residual voltage		1.5 V max.	
ON delay		0.1 ms max.	
OFF delay		1 ms max. (see note 2)	

**Note:** 1. The maximum switching capacity of the CPM1A with transistor outputs (sink type and source type) are limited to the currents shown in the following table for the common and for the Unit.

Item	10CDT-V1/ 10CDT1-A-V1/D-V1	20CDT-D-V1/ 20CDT1-A-V1/D-V1	30CDT-D-V1/ 30CDT1-A-V1/D-V1	40CDT-D-V1/ 40CDT1-A-V1/D-V1	20EDT/ 20EDT1	CPM1A-8ET/ 8ET1
Max. switching capacity	0.9 A/Unit	0.9 A/common 1.8 A/Unit	0.9 A/common 2.7 A/Unit	0.9 A/common 3.6 A/Unit	0.9 A/common 1.8 A/Unit	

2. When using the pulse output function of the CPM1A with transistor outputs (sink type and source type):  
The output current must be within a range from 100 to 200 mA when using the output 01000 or 01001 as a pulse output with the maximum frequency of 2 kHz. The outputs 01000 and 01001 will vary depending on the output current.

Load current	OFF delay
100 to 200 mA	0.2 ms max.
0 to 300 mA except for the above range	0.5 ms max.

# Specifications

## ■ Analog I/O Unit

		CPM1A-MAD01		CPM1A-MAD11	
		Voltage I/O	Current I/O	Voltage I/O	Current I/O
Analog inputs	Number of inputs	2		2 (2 words allocated)	
	Input signal range	0 to 10 V/1 to 5 V	4 to 20 mA	0 to 5 V/1 to 5 V/0 to 10 V/-10 to 10 V	0 to 20 mA/ 4 to 20 mA
	Maximum rated input	±15 V	±30 mA	±15 V	±30 mA
	External input impedance	1 MΩ min.	250 Ω rated	1 MΩ min.	250 Ω
	Resolution	1/256		1/6,000 (full scale)	
	Overall precision	1.0% of full scale		25°C: ±0.3% of full scale	25°C: ±0.4% of full scale
				0 to 55°C: ±0.6% of full scale	0 to 55°C: ±0.8% of full scale
Converted A/D data	8-bit binary		Binary data (hexadecimal, 4 digits) -10 to 10 V input range: Full scale = F448 to 0BB8 Hex Other input ranges: Full scale = 0000 to 1770 Hex		
Analog outputs (See note 2.)	Averaging	---		Supported (Set for each input using a DIP switch.)	
	Disconnection detection	---		Supported	
	Number of outputs	1		1 (1 word allocated)	
	Output signal range	0 to 10 V/ -10 to 10 V	4 to 20 mA	1 to 5 V/0 to 10 V/ -10 to 10 V	0 to 20 mA/ 4 to 20 mA
	External output max. current	5 mA	---	---	---
	External output allowed load resistance	---	350 Ω	1 kΩ min.	600 Ω max.
	External output impedance	---		0.5 Ω max.	---
	Resolution	1/256 (1/512 for output signal range -10 to 10 V)		1/6,000 (full scale)	
	Overall precision	1.0% of full scale		25°C: ±0.4% of full scale	
				0 to 55°C: ±0.8% of full scale	
Data setting	8-bit binary with sign bit		---		
Set D/A data	---		Binary data (hexadecimal, 4 digits) -10 to 10 V input range: Full scale = F448 to 0BB8 Hex Other input ranges: Full scale = 0000 to 1770 Hex		
Conversion time	10 ms/Unit max. (See note 1.)		2 ms/point (6 ms for all points)		
Isolation method	Photocoupler isolation between I/O terminals and PLC (There is no isolation between the analog I/O signals.)		Photocoupler isolation between analog I/O and internal circuits (There is no isolation between the analog I/O signals.)		

**Note 1.** The conversion time is the total time for 2 analog inputs and 1 analog output.

**2.** The voltage output and current output can be used at the same time, but the total output current cannot exceed 21 mA.

## ■ CompoBus/S I/O Link Unit

### Specifications

Item	Specification
Model number	CPM1A-SRT21
Master/Slave	CompoBus/S Slave
Number of I/O bits	8 input bits, 8 output bits
Number of words occupied in CPM1A I/O memory	1 input word, 1 output word (Allocated in the same way as other Expansion Units)
Node number setting	Set using the DIP switch.

**Note:** See the *CompoBus/S Catalog (Q103)* for more details on CompoBus/S communications.

# Specifications

## ■ CPM1A-DRT21 DeviceNet I/O Link Unit

By connecting the DeviceNet I/O Link Unit (CPM1A-DRT21), the CPM2A can function as the slave of a DeviceNet D Master Unit. In this configuration, I/O links for up to 32 inputs and 32 outputs can be created.

### Specifications

Item	Specification
Master/slave	DeviceNet slave
Model number	CPM1A-DRT21
Number of I/O points between Unit and Master	Input: 32 points Output: 32 points
Number of words allocated from CPM2A's I/O memory	Input: 2 words Output: 2 words (Allocated in the same way as other Expansion Units.)
Node address setting method	Set using DIP switch.
Maximum number of connectable nodes	63 (CS1) 32 (CVM1/CV) 25 (C200HX/HG/HE) 16 (C200HS) (The series names in parentheses are for the CPU Unit to which the Master Unit is mounted.)

## ■ Temperature Sensor Units

By mounting a Temperature Sensor Unit (CPM1A-TS001/TS002/TS101/TS102) to the PC, input can be obtained from a thermocouple or platinum resistance thermometer, and temperature measurements can be converted to binary data (4-digit hexadecimal) and stored in the input area of the CPU Unit. For details on the maximum number of connectable Units, refer to 7.

### Specifications

Item	Specification	
Model number	CPM1A-TS001/002	CPM1A-TS101/102
Number of inputs	2 (TS001), 4 (TS002)	2 (TS101), 4 (TS102)
Input types	K, J switchable (Note: Same input for all input points.)	Pt100, JPt100 switchable (Note: Same input for all input points.)
Indication accuracy	[The larger of the indicated value $\pm 0.5\%$ and $\pm 2^\circ\text{C}$ ] $\pm 1$ digit max.	[The larger of the indicated value $\pm 0.5\%$ and $\pm 1^\circ\text{C}$ ] $\pm 1$ digit max.
Conversion time	250 ms/2 points (TS001, TS101); 250 ms/4 points (TS002, TS102)	
Converted temperature data	Binary (4-digit hexadecimal)	
Isolation method	Photocoupler isolation between the temperature input signals.	

**Note:** The indication accuracy when using a K-type thermocouple for temperatures less than  $-100^\circ\text{C}$  is  $\pm 4^\circ\text{C} \pm 1$  digit max.

### Input Temperature Ranges for CPM1A-TS001/002

The rotary switch can be used to make of the following range and input type settings for CPM1A-TS001/002 models.

Input type	Range ( $^\circ\text{C}$ )		Range ( $^\circ\text{F}$ )
K	-200 to 1300		-300 to 2300
	0.0 to 500.0		0.0 to 900.0
J	-100 to 850		-100 to 1500
	0.0 to 400.0		0.0 to 750.0

### Input Temperature Ranges for CPM1A-TS101/102

The rotary switch can be used to make of the following range and input type settings for CPM1A-TS101/102 models.

Input type	Range ( $^\circ\text{C}$ )		Range ( $^\circ\text{F}$ )
Pt100	-200.0 to 650.0		-300 to 1200.0
JPt100	-200.0 to 650.0		-300 to 1200.0

# Specifications

## ■ Communications Adapter Specifications CPM1-CIF01/CIF11

### RS-232C Adapter and RS-422 Adapter

Item	Specifications	
	CPM1-CIF01	CPM1-CIF11
Functions	Level conversion between the CMOS level (CPU side) and the RS-232C (peripheral device side)	Level conversion between the CMOS level (CPU side) and the RS-422 (peripheral device side)
Insulation	The RS-232C (peripheral device side) is insulated by a DC/DC converter and photocoupler.	The RS-422 (peripheral device side) is insulated by a DC/DC converter and photocoupler.
Power supply	Power is supplied by the CPU.	
Power consumption	0.3 A max.	
Transmission speed	38.4 Kbits/s max.	
Vibration resistance	10 to 57 Hz with an amplitude of 0.075 mm, and 57 to 150 Hz with an acceleration of 9.8 m/s <sup>2</sup> in the X, Y and Z directions for 80 minutes each in accordance (i.e. swept for 8 minutes, 10 times).	
Shock resistance	147 m/s <sup>2</sup> in the X, Y and Z directions 3 times each.	
Ambient temperature (operating)	0° to 55°C	
Ambient humidity (operating)	10% to 90% (with no condensation)	
Ambient environment (operating)	With no corrosive gas	
Ambient temperature (storage)	-20° to 75°C	
Weight	200 g max.	

## ■ Memory Backup

The user program and memory area data in the CPU Unit are backed up by either one of the following methods.

- Flash Memory:  
User program, read-only DM area (DM 6144 to DM 6599), and PC Setup area (DM 6600 to DM 6655).
- Internal Capacitor:  
DM areas other than the above, HR area, AR area, and Counter area.

The capacitor provides backup for a power interruption lasting 20 days at room temperature. If the power is expected to remain OFF for a period exceeding this data backup period, consideration must be given to the design of the system so that no problems will occur when the set values become undefined ones. For further details, refer to *CPM1A Operation Manual (W317)*.

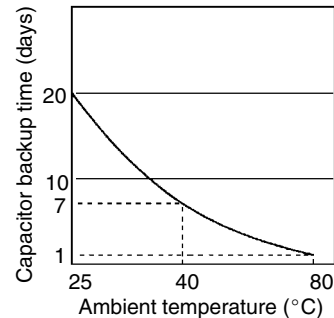

# Specifications

## ■ CPM2C-PA201 AC Power Supply Unit

The CPM2C-PA201 is a compact, streamlined Unit that can be used as the power supply for PCs, such as the CPM1A and CPM2A, and indicators. (When using the CPM2C-PA201, connection must be performed by the user.)

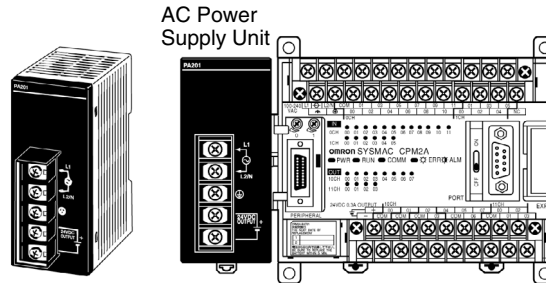

## Specifications

Item		Specification	
Rated output		15 W	
Output voltage		24 VDC	
Output current		600 mA	
Efficiency		75% min. (at rated output)	
Input conditions	Rated voltage	100 to 240 VAC	
	Allowable voltage range	85 to 264 VAC	
	Frequency	47 to 63 Hz	
	Current	100 V	0.4 A
		200 V	0.2 A
	Leakage current	100 V	0.5 mA max. (at rated output)
		200 V	1 mA max. (at rated output)
Inrush current	100 V	15 A (at 25°C cold start)	
	200 V	30 A (at 25°C cold start)	
Output characteristics	Output voltage accuracy	5%/–10% max.; 10%/–15% max. (including input, load, and temperature fluctuations)	
	Minimum output current	30 mA	
	Ripple noise voltage	2% (p-p) max.	
	Input fluctuation	0.75% max.	
	Load fluctuation	4% max.	
	Temperature fluctuation	0.05%/°C max.	
	Startup time	300 ms max. (at input voltage of 100 VAC or 200 VAC and the rated output)	
Output hold time	10 ms (at input voltage of 100 VAC or 200 VAC and the rated output)		
Overcurrent protection		Self-resetting, operates at 105% to 335% of the rated current, suspended and intermittent operation	
Overvoltage protection		None	
Ambient operating temperature		0 to 55°C	
Ambient storage temperature		–20 to 70°C (no condensation or icing)	
Ambient operating humidity		10% to 90%	
Dielectric strength		2,000 V for 1 min between all inputs and GR Detection current: 10 mA  3,000 V for 1 min between all inputs and all outputs Detection current: 10 mA  1,000 V for 1 min between all outputs and GR Detection current: 10 mA	
Insulation resistance		100 MΩ min. at 500 VDC between all outputs and any input, and between all outputs and GR	
Vibration resistance		10 to 57 Hz, double amplitude of 0.075 mm, 57 to 150 Hz, acceleration: 9.8 m/s <sup>2</sup> in X, Y, and Z directions for 80 minutes according (Time coefficient: 8 minutes × coefficient factor 10 = total time 80 min.)	
Shock resistance		147 m/s <sup>2</sup> 3 times each in X, Y, and Z directions	
Noise terminal voltage		FCC class A	
Weight		250 g max.	
External dimensions		40 × 65 × 90 mm (W × H × D)	

# Functions

## ■ Input Interrupts

There are two input interrupts in the CPM1A 10-point I/O CPU and four in the 20-, 30-, and 40-point I/O CPUs. Input interrupts are available in two modes.

10-point I/O CPU

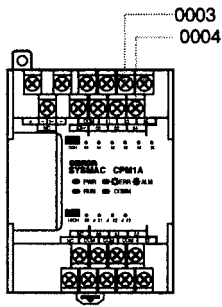

20-, 30-, and 40-point I/O CPU

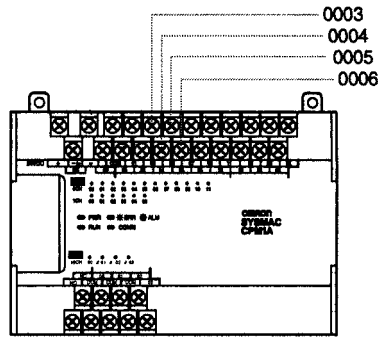

### Application Example:

#### Cutting Metal Sheets to Specified Lengths

The proximity sensor detects the edge of a metal plate to operate the cutter. Metal sheets can be cut continuously to the specified lengths at a high speed.

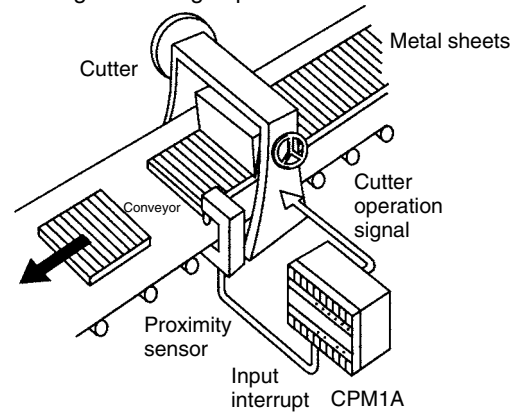

### Input Interrupt Mode

If an input interrupt occurs, the regular program shuts down irrelevant of the cycle time, and the interrupt processing program is executed immediately.

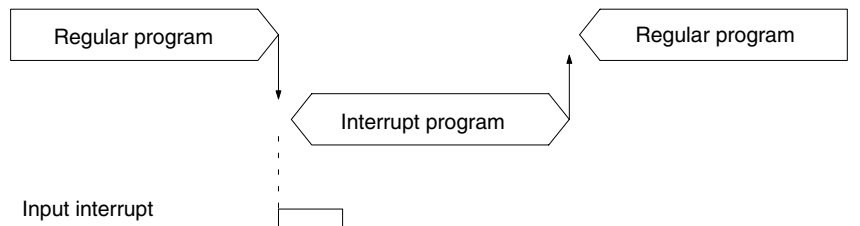

### Counter Mode

When the number of external signals counted at high speed reaches a specified number of counts, the regular program shuts down, and the interrupt processing program is executed at fixed counts. The count can be set between 0 and 65535.

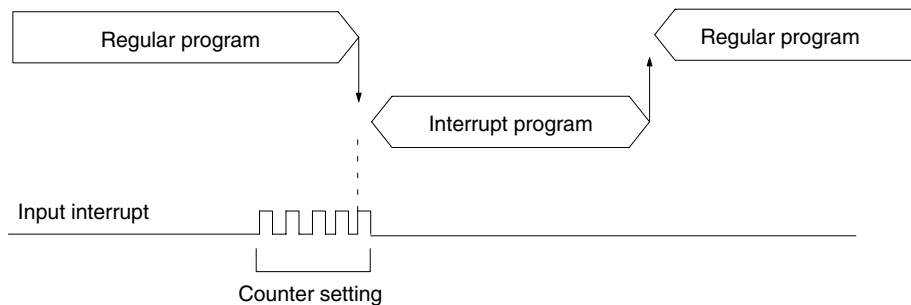

## ■ Quick-response Inputs

There are two quick-response inputs for the CPM1A 10-point I/O CPU and four for the 20-, 30-, and 40-point I/O CPU (shared with the interrupt inputs). Since an internal buffer is provided, the quick-response input function can even detect signals modified within one cycle.

CPU	Input no.	Minimum input pulse width
10-point I/O CPU	00003 to 00004	0.2 ms
20-point, 30-point, 40-point I/O CPU	00003 to 00006	

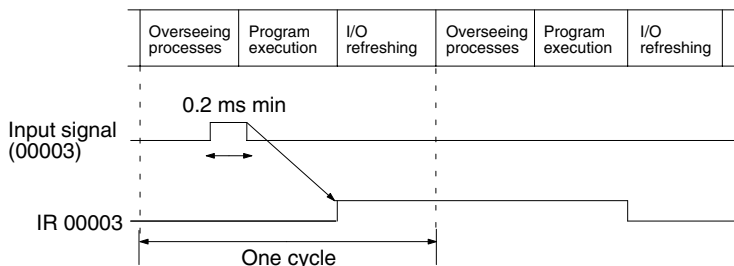

### Application Example:

#### Calculating the Number of Chips

The metal sensor counts the number of parts that have passed. Steady counting can be achieved even when the input-ON time is short.

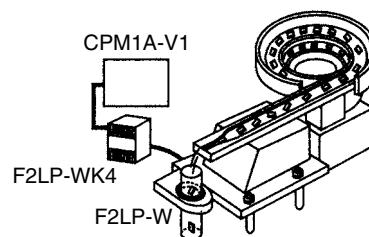

## ■ High-speed Counter

The CPM1A has a high-speed counter function that can be used in the incrementing and up/down mode. Using this function together with the input interrupts enables zone comparison control or target value control irrelevant of the cycle time.

Item		Incrementing mode	Up/Down mode
Input no.	00000	Count input	A-phase input
	00001	---	B-phase input
	00002	Reset input	Z-phase input
Input method		Single-phase input	Phase-difference, 4× inputs
Count frequency		5.0 kHz	2.5 kHz
Count range		0 to 65535	-32767 to 32767

**Note:** When using in the incrementing mode, the input 00001 can be used as an input contact.

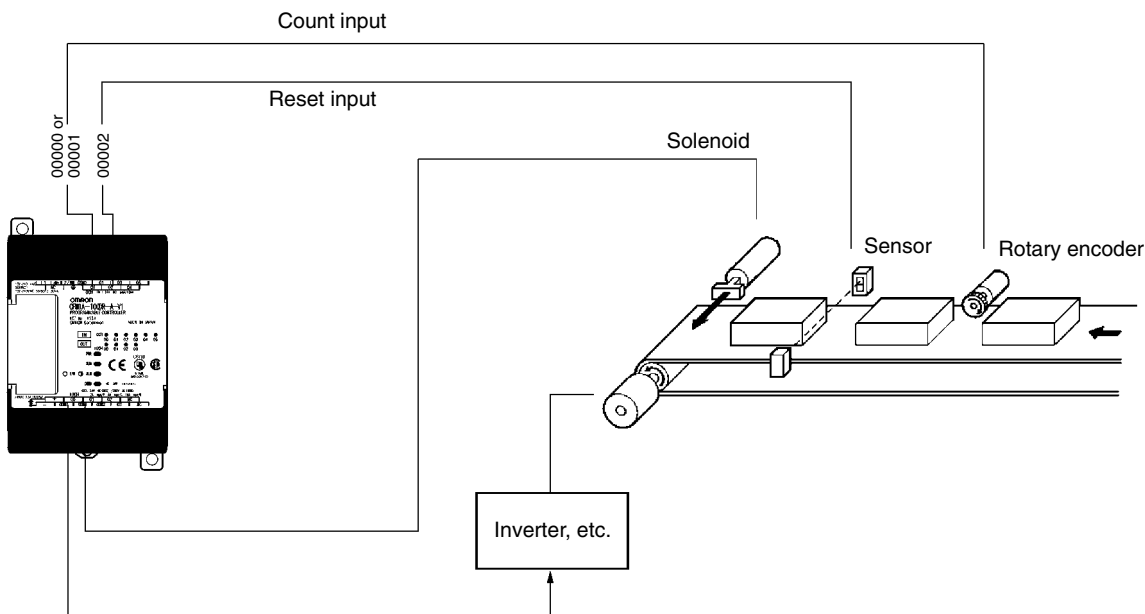

# Functions

## ■ Interval Timer Interrupts

The CPM1A has one interval timer. The interval timer shuts down the regular program irrelevant of the point in the cycle once the time is up, and immediately executes an interrupt processing program. Interval timers are used in the following two modes.

Item	One-shot mode	Scheduled interrupt mode
Operation	An interrupt is executed only once when the time is up.	Interrupts are executed repeatedly at fixed periods.
Setting time	0.5 ms to 319,968 ms (0.1-ms units)	

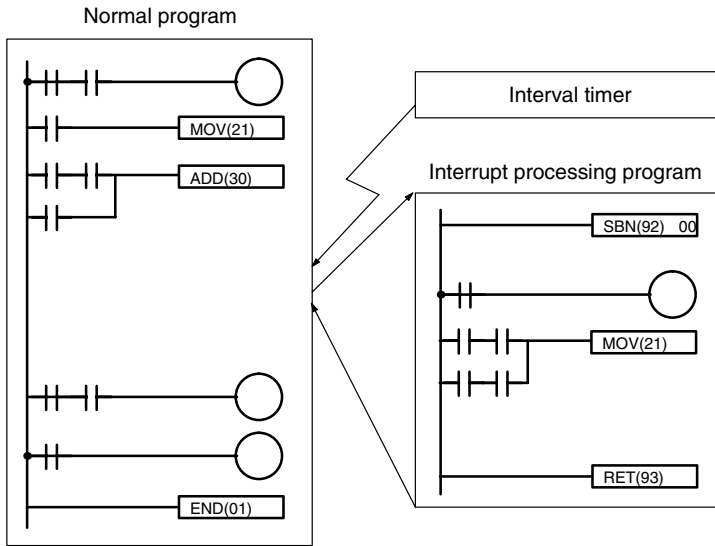

### Application Example:

#### Computing the Sheet Speed

The number of pulse inputs is computed in the interrupt mode at a fixed time to calculate the speed.

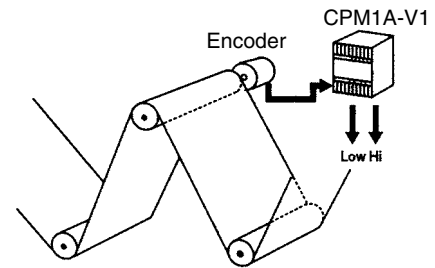

## ■ Analog Setting

The CPM1A contains two analog setting controls that can be used for a broad range of analog timer and counter settings. Turning the setting control stores values of 0 to 200 (BCD data) in the SR area.

Analog setting	Storage area	Setting value (BCD)
Analog setting 0	SR 250	0000 to 0200
Analog setting 1	SR 251	

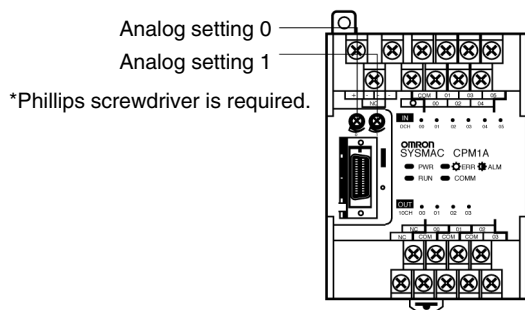

### Application Example:

#### Tact Operation Control of Conveyor Lines

A conveyor can be stopped temporarily as required for assembly processes. When the timer function and limit switches are used in a combination, conveyors can be stopped for a fixed time or can be run at a constant speed for a fixed distance. Fine adjustment of the stopping time can be easily done by using the analog setting controls.

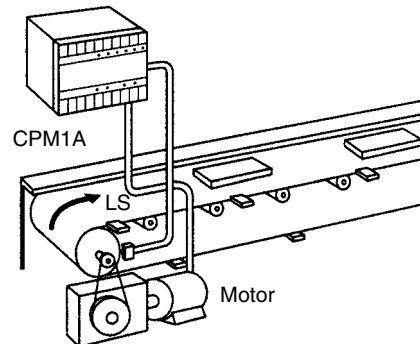



## Program Example

1. Analog timer for 0.0 to 20.0 seconds

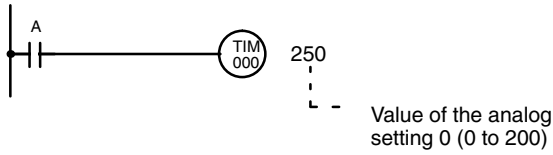

2. Analog timer for 0.0 to 60.0 seconds

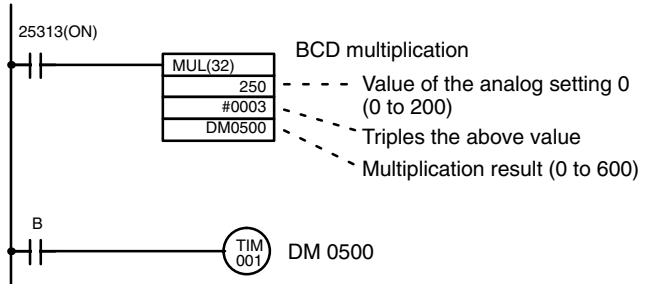

## ■ Pulse Output Function

The CPM1A with transistor output has a function that is capable of outputting a pulse of up to 2 kHz.

When used in combination with a Stepping Driver or Servodriver, positioning can be easily performed.

## Application Example

Changing the speed of the Stepping Motor.

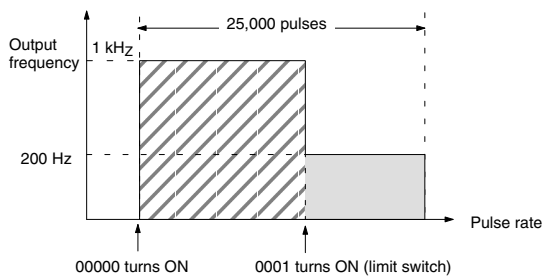
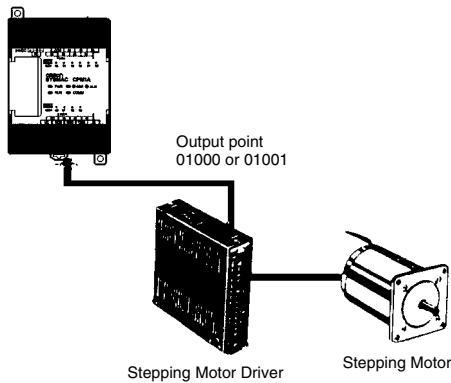

## Program Example

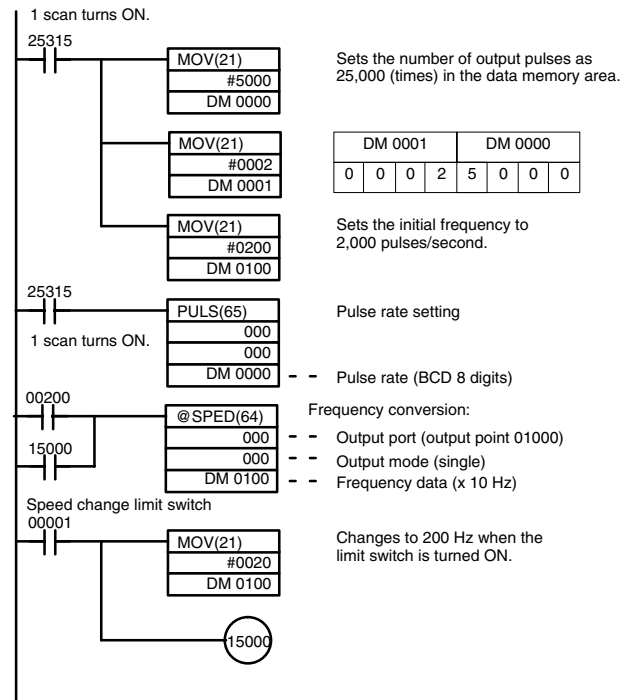

# Functions

## ■ Communications

### Host Link Communications

CPM1A host link communications consist of interactive procedures whereby the CPM1A returns a response to a command sent from the IBM PC/AT or compatible computer. These communications allow the IBM PC/AT or compatible computer to read and write in the CPM1A's I/O Areas and Data Memory Areas as well as in areas containing the status of various settings.

#### 1:1 Host Link Communications

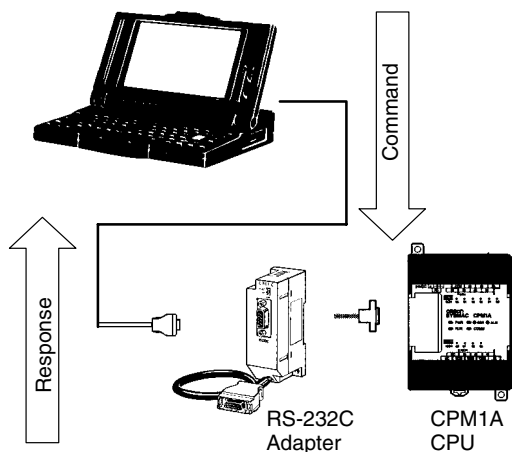

#### 1:n Host Link Communications

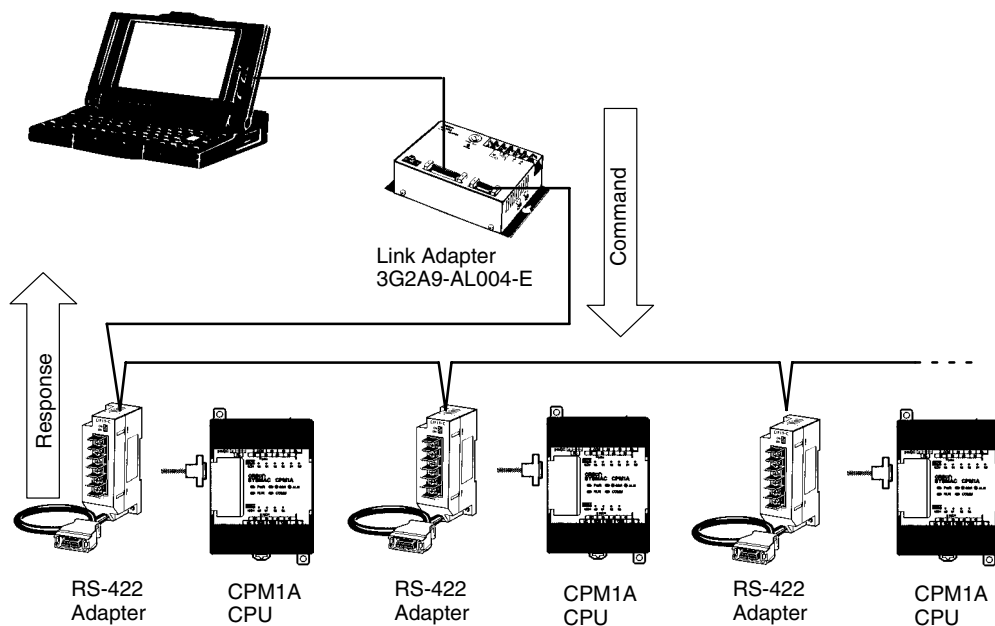

## 1:1 Links

With a 1:1 link, two CPM1As or a CPM1A and CQM1 or C200H□ are connected 1:1 with one side as the Master and the other as the Slave to provide an I/O link of a maximum of 256 points (LR 0000 to LR 1515).

### Example of a 1:1 Link between CPM1As

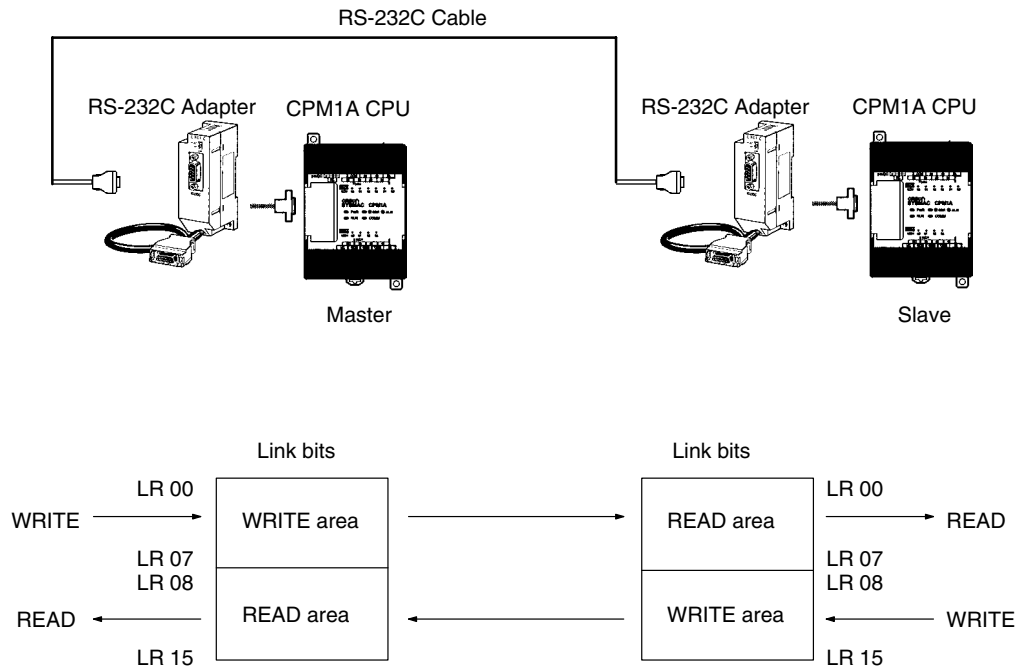

### Limitations of the CPM1A 1:1 Link

CPM1A I/O links are limited to 16 words (LR 00 to LR 15). Therefore, use these 16 words (LR 00 to LR 15) on the CQM1 or C200H□ side when forming 1:1 links with a CQM1 or C200H□.

## NT Links

High-speed communications can be achieved by providing a direct access through the use of the NT Link between the CPM1A and Programmable Terminal.

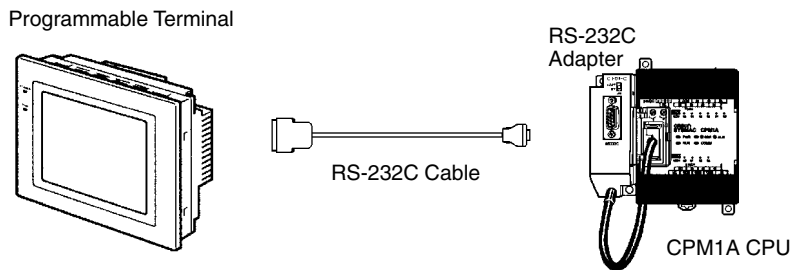

# Programming Instructions

## Summary of Programming Instructions

### ■ Function Code Chart

Table symbols	Details	Key operations for specifying programming instructions
○	Allocated to instruction keys on the Programming Console. These need not be specified with function codes.	---
Code	Special instructions specified with function codes.	FUN → Code → WRITE

### ■ Differentiated Instructions

Differentiated instructions can sometimes be used for CPM1A special instructions. Instructions marked with (@) in the mnemonics can also be used as differentiated instructions. Here the input rise time (shift from OFF to ON) is used to execute the instruction in just one cycle.

To specify an instruction, press the NOT Key after the function code.

Example: Specifying the @MOV (21) instruction

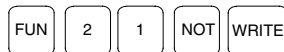

### ■ Sequence Instructions

#### Sequence Input Instructions

Instruction	Mnemonic	Code	Function
LOAD	LD	○	Connects an NO condition to the left bus bar.
LOAD NOT	LD NOT	○	Connects an NC condition to the left bus bar.
AND	AND	○	Connects an NO condition in series with the previous condition.
AND NOT	AND NOT	○	Connects an NC condition in series with the previous condition.
OR	OR	○	Connects an NO condition in parallel with the previous condition.
OR NOT	OR NOT	○	Connects an NC condition in parallel with the previous condition.
AND LOAD	AND LD	○	Connects two instruction blocks in series.
OR LOAD	OR LD	○	Connects two instruction blocks in parallel.

**Note:** ○: Instruction keys allocated to the Programming Console.

#### Sequence Output Instructions

Instruction	Mnemonic	Code	Function
OUTPUT	OUT	○	Outputs the result of logic to a bit.
OUT NOT	OUT NOT	○	Reverses and outputs the result of logic to a bit.
SET	SET	○	Force sets (ON) a bit.
RESET	RSET	○	Force resets (OFF) a bit.
KEEP	KEEP	11	Maintains the status of the designated bit.
DIFFERENTIATE UP	DIFU	13	Turns ON a bit for one cycle when the execution condition goes from OFF to ON.
DIFFERENTIATE DOWN	DIFD	14	Turns ON a bit for one cycle when the execution condition goes from ON to OFF.

**Note:** ○: Instruction keys allocated to the Programming Console.

#### Sequence Control Instructions

Instruction	Mnemonic	Code	Function
NO OPERATION	NOP	00	---
END	END	01	Required at the end of the program.
INTERLOCK	IL	02	If the execution condition for IL(02) is OFF, all outputs are turned OFF and all timer PVs reset between IL(02) and the next ILC(03).
INTERLOCK CLEAR	ILC	03	ILC(03) indicates the end of an interlock (beginning at IL(02)).
JUMP	JMP	04	If the execution condition for JMP(04) is ON, all instructions between JMP(04) and JME(05) are treated as NOP(00).
JUMP END	JME	05	JME(05) indicates the end of a jump (beginning at JMP(04)).

### ■ Timer/Counter Instructions

Instruction	Mnemonic	Code	Function
TIMER	TIM	○	An ON-delay (decrementing) timer.
COUNTER	CNT	○	A decrementing counter.
REVERSIBLE COUNTER	CNTR	12	Increases or decreases PV by one.
HIGH-SPEED TIMER	TIMH	15	A high-speed, ON-delay (decrementing) timer.

**Note:** ○: Instruction keys allocated to the Programming Console.

# Programming Instructions

## ■ Step Instructions

Instruction	Mnemonic	Code	Function
STEP DE-FINE	STEP	08	Defines the start of a new step and resets the previous step when used with a control bit. Defines the end of step execution when used without a control bit.
STEP START	SNXT	09	Starts the execution of the step when used with a control bit.

## ■ Increment/Decrement Instructions

Instruction	Mnemonic	Code	Function
INCREMENT	(@)INC	38	Increments the BCD content of the specified word by 1.
DECREMENT	(@)DEC	39	Decrements the BCD content of the specified word by 1.

## ■ BCD/Binary Calculation Instructions

Instruction	Mnemonic	Code	Function
BCD ADD	(@)ADD	30	Adds the content of a word (or a constant).
BCD SUBTRACT	(@)SUB	31	Subtracts the content of a word (or constant) and CY from the content of a word (or constant).
BCD MULTIPLY	(@)MUL	32	Multiplies the contents of two words (or constants).
BCD DIVIDE	(@)DIV	33	Divides the content of a word (or constant) by the content of a word (or constant).
BINARY ADD	(@)ADB	50	Adds the contents of two words (or constants) and CY.
BINARY SUBTRACT	(@)SBB	51	Subtracts the content of a word (or constant) and CY from the content of a word (or constant).
BINARY MULTIPLY	(@)MLB	52	Multiplies the contents of two words (or constants).
BINARY DIVIDE	(@)DVB	53	Divides the content of a word (or constant) by the content of a word and obtains the result and remainder.
DOUBLE BCD ADD	(@)ADDL	54	Add the 8-digit BCD contents of two pairs of words (or constants) and CY.
DOUBLE BCD SUBTRACT	(@)SUBL	55	Subtracts the 8-digit BCD contents of a pair of words (or constants) and CY from the 8-digit BCD contents of a pair of words (or constants).
DOUBLE BCD MULTIPLY	(@)MULL	56	Multiplies the 8-digit BCD contents of two pairs of words (or constants).
DOUBLE BCD DIVIDE	(@)DIVL	57	Divides the 8-digit BCD contents of a pair of words (or constants) by the 8-digit BCD contents of a pair of words (or constants).

## ■ Data Conversion Instructions

Instruction	Mnemonic	Code	Function
BCD TO BINARY	(@)BIN	23	Converts 4-digit BCD data to 4-digit binary data.
BINARY TO BCD	(@)BCD	24	Converts 4-digit binary data to 4-digit BCD data.
4 TO 16 DECODER	(@)MLPX	76	Takes the hexadecimal value of the specified digit(s) in a word and turns ON the corresponding bit in a word(s).
16 TO 4 DECODER	(@)DMPX	77	Identifies the highest ON bit in the specified word(s) and moves the hexadecimal value(s) corresponding to its location to the specified digit(s) in a word.
ASCII CODE CONVERT	(@)ASC	86	Converts the designated digit(s) of a word into the equivalent 8-bit ASCII code.

## Data Comparison Instructions

Instruction	Mnemonic	Code	Function
COMPARE	CMP	20	Compares two four-digit hexadecimal values.
DOUBLE COMPARE	CMPL	60	Compares two eight-digit hexadecimal values.
BLOCK COMPARE	(@)BCMP	68	Judges whether the value of a word is within 16 ranges (defined by lower and upper limits).
TABLE COMPARE	(@)TCMP	85	Compares the value of a word to 16 consecutive words.

# Programming Instructions

## ■ Data Movement Instructions

Instruction	Mnemonic	Code	Function
MOVE	(@)MOV	21	Copies a constant or the content of a word to a word.
MOVE NOT	(@)MVN	22	Copies the complement of a constant or the content of a word to a word.
BLOCK TRANSFER	(@)XFER	70	Copies the content of a block of up to 1,000 consecutive words to a block of consecutive words.
BLOCK SET	(@)BSET	71	Copies the content of a word to a block of consecutive words.
DATA EXCHANGE	(@)XCHG	73	Exchanges the content of two words.
SINGLE WORD DISTRIBUTE	(@)DIST	80	Copies the content of a word to a word (whose address is determined by adding an offset to a word address).
DATA COLLECT	(@)COLL	81	Copies the content of a word (whose address is determined by adding an offset to a word address) to a word.
MOVE BIT	(@)MOVB	82	Copies the specified bit from one word to the specified bit of a word.
MOVE DIGIT	(@)MOVD	83	Copies the specified digits (4-bit units) from a word to the specified digits of a word.

## ■ Logic Instructions

Instruction	Mnemonic	Code	Function
COMPLEMENT	(@)COM	29	Turns OFF all ON bits and turns ON all OFF bits in the specified word.
LOGICAL AND	(@)ANDW	34	Logically ANDs the corresponding bits of two words (or constants).
LOGICAL OR	(@)ORW	35	Logically ORs the corresponding bits of two words (or constants).
EXCLUSIVE OR	(@)XORW	36	Exclusively ORs the corresponding bits of two words (or constants).
EXCLUSIVE NOR	(@)XNRW	37	Exclusively NORs the corresponding bits of two words (or constants).

## ■ Shift Instructions

Instruction	Mnemonic	Code	Function
SHIFT REGISTER	SFT	○/10	Copies the specified bit (0 or 1) into the rightmost bit of a shift register and shifts the other bits one bit to the left.
WORD SHIFT	(@)WSFT	16	Creates a multiple-word shift register that shifts data to the left in one-word units.
ASYNCHRONOUS SHIFT REGISTER	(@)ASFT	17	Creates a shift register that exchanges the contents of adjacent words when one is zero and the other is not.
ARITHMETIC SHIFT LEFT	(@)ASL	25	Shifts a 0 into bit 00 of the specified word and shifts the other bits one bit to the left.
ARITHMETIC SHIFT RIGHT	(@)ASR	26	Shifts a 0 into bit 15 of the specified word and shifts the other bits one bit to the right.
ROTATE LEFT	(@)ROL	27	Moves the content of CY into bit 00 of the specified word, shifts the other bits one bit to the left, and moves bit 15 to CY.
ROTATE RIGHT	(@)ROR	28	Moves the content of CY into bit 15 of the specified word, shifts the other bits one bit to the right, and moves bit 00 to CY.
ONE DIGIT SHIFT LEFT	(@)SLD	74	Shifts a 0 into the rightmost digit (4-bit unit) of the shift register and shifts the other digits one digit to the left.
ONE DIGIT SHIFT RIGHT	(@)SRD	75	Shifts a 0 into the leftmost digit (4-bit unit) of the shift register and shifts the other digits one digit to the right.
REVERSIBLE SHIFT REGISTER	(@)SFTR	84	Creates a single or multiple-word shift register that can shift data to the left or right.

**Note:** ○: Instruction keys allocated to the Programming Console.

## ■ Special Calculation Instruction

Instruction	Mnemonic	Code	Function
BIT COUNTER	(@)BCNT	67	Counts the total number of bits that are ON in the specified block of words.

# Programming Instructions

## ■ Subroutine Instructions

Instruction	Mnemonic	Code	Function
SUBROUTINE ENTRY	(@)SBS	91	Executes a subroutine in the main program.
SUBROUTINE ENTRY	SBN	92	Marks the beginning of a subroutine program.
SUBROUTINE RETURN	RET	93	Marks the end of a subroutine program.
MACRO	MCRO	99	Calls and executes the specified subroutine, substituting the specified input and output words for the input and output words in the subroutine.

## ■ Interrupt Control Instructions

Instruction	Mnemonic	Code	Function
INTERVAL TIMER	(@)STIM	69	Controls interval timers used to perform scheduled interrupts.
INTERUPT CONTROL	(@)INT	89	Performs interrupt control, such as masking and unmasking the interrupt bits for I/O interrupts.

## ■ Peripheral Device Control Instructions

### I/O Unit Instructions

Instruction	Mnemonic	Code	Function
7-SEGMENT DECODER	(@)SDEC	78	Converts the designated digit(s) of a word into an 8-bit, 7-segment display code.
I/O REFRESH	(@)IORF	97	Refreshes the specified I/O word.

### Display Instruction

Instruction	Mnemonic	Code	Function
MESSAGE	(@)MSG	46	Reads up to 8 words of ASCII code (16 characters) from memory and displays the message on the Programming Console or other Peripheral Device.

## High-speed Counter Control Instructions

Instruction	Mnemonic	Code	Function
MODE CONTROL	(@)INI	61	Starts and stops counter operation, compares and changes counter PVs, and stops pulse output.
PV READ	(@)PRV	62	Reads counter PVs and status data.
COMPARE TABLE LOAD	(@)CTBL	63	Compares counter PVs and generates a direct table or starts operation.

## Pulse Output Control Instructions

Instruction	Mnemonic	Code	Function
SPEED OUTPUT	(@)SPED	64	Outputs pulses at the specified frequency. The output frequency can be changed while the pulses are being output.
SET PULSES	(@)PULS	65	Outputs the specified number of pulses at the specified frequency. The pulse output cannot be stopped until the specified number of pulses have been output.

## ■ Damage Diagnosis Instructions

Instruction	Mnemonic	Code	Function
FAILURE ALARM	(@)FAL	06	Generates a non-fatal error when executed. The Error/Alarm indicator flashes and the CPU continues operating.
SEVERE FAILURE ALARM	FALS	07	Generates a fatal error when executed. The Error/Alarm indicator lights and the CPU stops operating.

## ■ Special System Instructions

Instruction	Mnemonic	Code	Function
SET CARRY	(@)STC	40	Sets Carry Flag 25504 to 1.
CLEAR CARRY	(@)CLC	41	Sets Carry Flag 25504 to 0.

# Peripheral Devices

CPM1A CPU

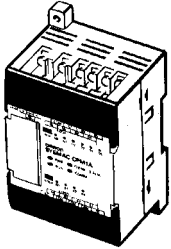

IBM PC/AT or compatible

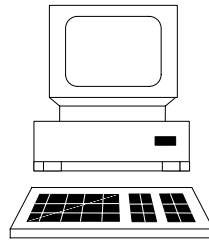

CX-Programmer: WS02-CXPC1-E-V4□  
(for Windows 95, 98, Me, NT 4.0, 2000, or XP)

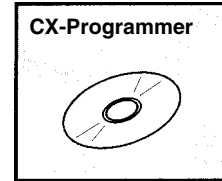

RS-232C    USB

USB-Serial Conversion Cable



CS1W-CIF31    *New*

Peripheral Device Connecting Cable

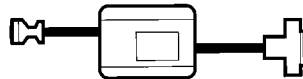

CQM1-CIF02

Programming Console  
Connecting Cable



C200H-CN222/CN422  
(2 m/4 m)

Programming  
Console

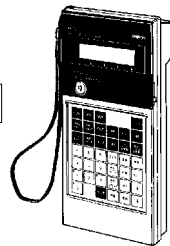

C200H-PRO27-E

Programming Console  
(With Connecting Cable)



CQM1-PRO01-E



# Standard Models

The abbreviations used in the “Standards” column in the following tables indicate the following international standards.

U: UL, C:CSA, UC: cULus, CU: cUL, N: NK, L: Lloyd, CE: EC Directives





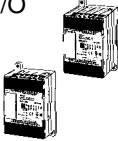
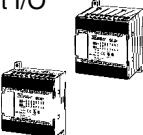
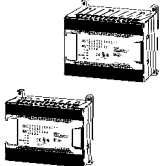
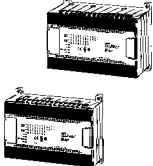



See OMRON sales representatives for conditions under which UL, CSA, cULus, cUL, NK, LLOYD, and CE standards were met.

## ■ CPU Units

Name	Power supply	Output method	Input points	Output points	Model	Standards
10-point I/O 	AC power supply	Relay output	6 points	4 points	CPM1A-10CDR-A-V1	U, C, N, L, CE
		Transistor output (sink type)			CPM1A-10CDT-A-V1	U, C, CE
		Transistor output (source type)			CPM1A-10CDT1-A-V1	U, C, CE
	DC power supply	Relay output			CPM1A-10CDR-D-V1	U, C, N, L, CE
		Transistor output (sink type)			CPM1A-10CDT-D-V1	U, C, CE, N
		Transistor output (source type)			CPM1A-10CDT1-D-V1	
20-point I/O 	AC power supply	Relay output	12 points	8 points	CPM1A-20CDR-A-V1	U, C, N, L, CE
		Transistor output (sink type)			CPM1A-20CDT-A-V1	U, C, CE
		Transistor output (source type)			CPM1A-20CDT1-A-V1	U, C, CE
	DC power supply	Relay output			CPM1A-20CDR-D-V1	U, C, N, L, CE
		Transistor output (sink type)			CPM1A-20CDT-D-V1	U, C, CE, N
		Transistor output (source type)			CPM1A-20CDT1-D-V1	
30-point I/O 	AC power supply	Relay output	18 points	12 points	CPM1A-30CDR-A-V1	U, C, N, L, CE
		Transistor output (sink type)			CPM1A-30CDT-A-V1	U, C, CE
		Transistor output (source type)			CPM1A-30CDT1-A-V1	U, C, CE
	DC power supply	Relay output			CPM1A-30CDR-D-V1	U, C, N, L, CE
		Transistor output (sink type)			CPM1A-30CDT-D-V1	U, C, CE, N
		Transistor output (source type)			CPM1A-30CDT1-D-V1	
40-point I/O 	AC power supply	Relay output	24 points	16 points	CPM1A-40CDR-A-V1	U, C, N, L, CE
		Transistor output (sink type)			CPM1A-40CDT-A-V1	U, C, CE
		Transistor output (source type)			CPM1A-40CDT1-A-V1	U, C, CE
	DC power supply	Relay output			CPM1A-40CDR-D-V1	U, C, N, L, CE
		Transistor output (sink type)			CPM1A-40CDT-D-V1	U, C, CE, N
		Transistor output (source type)			CPM1A-40CDT1-D-V1	



# Standard Models

## ■ Expansion I/O Units

Expansion Unit	Max. number of Units	Output type	Inputs	Outputs	Model	Standards	
Expansion I/O Units	3 Units max. (See note.)	Relay	12	8		CPM1A-20EDR1	U, C, CE, N
		Transistor (sinking)				CPM1A-20EDT	U, C, CE, N
		Transistor (sourcing)				CPM1A-20EDT1	U, C, CE, N
		---	8	---		CPM1A-8ED	U, C, CE, N
		Relay	---	8		CPM1A-8ER	U, C, CE, N
		Transistor (sinking)	---	8		CPM1A-8ET	U, C, CE, N
		Transistor (sourcing)	---	8		CPM1A-8ET1	U, C, L, CE, N
Analog I/O Unit	3 Units max. (See note.)	Analog (resolution: 1/256)	2	1		CPM1A-MAD01	U, C, CE, N
	3 Units max. (See note.)	Analog (resolution: 1/6000)	2	1		CPM1A-MAD11	U, C, CE, N
DeviceNet I/O Link Unit	3 Units max. (See note.)	---	32 (I/O link input bits)	32 (I/O link output bits)		CPM1A-DRT21	U, C, CE, N
CompoBus/S I/O Link Unit	3 Units max. (See note.)	---	I/O link of 8 input bits and 8 output bits			CPM1A-SRT21	U, C, CE, N

**Note:** Only one Expansion Unit can be connected if an NT-AL001 Adapter is connected to the CPU Unit's RS-232C port.

## ■ Temperature Sensor Units

Unit	Output type	Model	Standards	
Temperature Sensor Units	2 thermocouple inputs	CPM1A-TS001		U, C, CE, N
	4 thermocouple inputs	CPM1A-TS002		U, C, CE, N
	2 platinum resistance thermometer inputs	CPM1A-TS101		U, C, CE, N
	4 platinum resistance thermometer inputs	CPM1A-TS102		U, C, CE, N

# Standard Models

## ■ RS-232C Adapter, RS-422 Adapter, Connecting Cable, Link Adapter

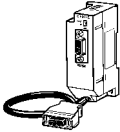
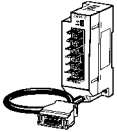
Name	Function	Model	Standards
RS-232C Adapter 	Converts peripheral port levels.	CPM1-CIF01	U, C, N, L, CE
RS-422 Adapter 		CPM1-CIF11	
Connecting Cable	3.3-m cable used to connect IBM PC/AT or compatible personal computers.	CQM1-CIF02	U, C, N, L, CE
USB-Serial Conversion Cable	Converts between USB and RS-232C, cable length: 0.5 m. PC Driver included (CD-ROM). Applicable OS: Windows 98, Me, 2000, or XP	CS1W-CIF31	N, CE
Link Adapter	Converts RS-232C and RS-422 levels.	3G2A9-AL004-E	---

## ■ Programming Console

Name	Function	Model	Standards
Programming Console 	With a 2-m cable	CQM1-PRO01-E	U, C, N, CE
	---	C200H-PRO27-E	U, C, N, CE
	2-m Connecting Cable for C200H-PRO27-E	C200H-CN222	N
	4-m Connecting Cable for C200H-PRO27-E	C200H-CN422	---

## ■ Programming Software

Name	Operating system	Operating environment	Model
CX-Programmer (1 licence)	Windows 95, 98, Me, NT 4.0, 2000, or XP	Used in IBM PC/AT or compatible personal computers (Pentium)	WS02-CXPC1-E-V4□
CX-Programmer Junior Version (1 license, supports CPM□□ and SRM1 only)	Windows 95, 98, Me, NT 4.0, 2000, or XP	Used in IBM PC/AT or compatible personal computers (Pentium)	WS02-CXPC1-EJ-V4□

## ■ Backup Accessories

Name	Model	Standards
Expansion Memory Unit	CPM1-EMU01-V1	---
256-K EEPROM for Expansion Memory Unit	EEROM-JD	---

## ■ Power Supply Unit

Unit	Input	Output	Model	Standards
AC Power Supply Unit	100 to 240 VAC	600 mA at 24 VDC	CPM2C-PA201 	U, C, CE

# Expansion Memory Unit

## ■ Expansion Memory Unit

The Expansion Memory Unit allows programs to be uploaded and downloaded between PC and EEPROM with the press of a button. It is a useful device for program maintenance and correction.

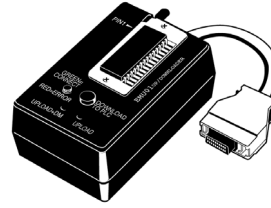

## ■ Connection Configuration

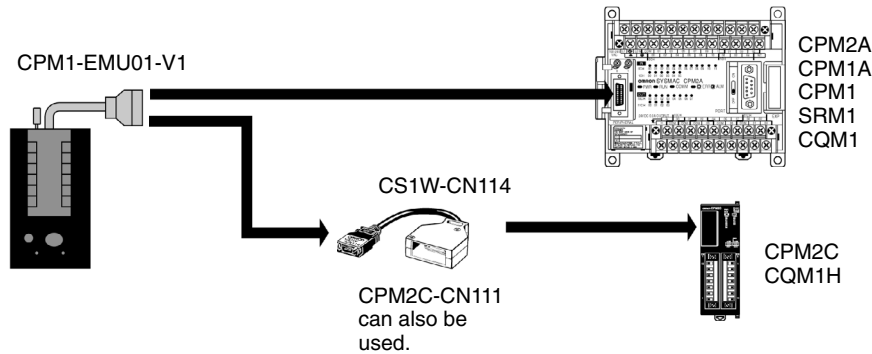

## ■ Specifications

Item	Specifications
Supported PCs	CPM1, CPM1A, CPM2A, CPM2C, SRM1 (-V2), CQM1, CQM1H
Read/Write memory areas	User program: 15.2 Kwords max. Data memory: DM 6144 to DM 6655 (Read-only DM and PC Setup) Expansion instructions: 18 instructions
Connector	Connector compatible with CPM1, CPM1A, CPM2A, SRM1 (-V2), and CQM1 PCs. For CPM2C and CQM1H PCs, connect via CS1W-CN114 or CPM2C-CN111 Connecting Cable.
EEPROM (sold separately)	256-Kbit EEPROM ATMEL: AT28C256 OMRON: EEROM-JD
Current consumption	129 mA max.
Dimensions	Main body (not including cables or connectors): 57 × 92 × 38 mm (W × H × D)
Weight	200 g max. (not including EEPROM)

## ■ Dimensions

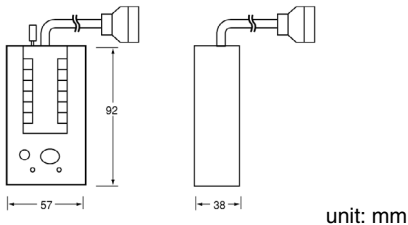

## ■ Memory Areas

The memory areas that are uploaded or downloaded vary with the button used as shown in the following table.

Memory area	Button		
	UPLOAD + DM	UPLOAD	DOWNLOAD
Ladder program and expansion instructions	Read from PC to EEPROM.	Read from PC to EEPROM.	All contents of EEPROM written to PC.
DM 6144 to 6655		Not affected.	

**Note:** For details on program size, DM area, and the availability of expansion instructions, refer to the relevant PC manual.

## Read and Understand this Catalog

Please read and understand this catalog before purchasing the product. Please consult your OMRON representative if you have any questions or comments.

## Warranty and Limitations of Liability

### WARRANTY

OMRON's exclusive warranty is that the products are free from defects in materials and workmanship for a period of one year (or other period if specified) from date of sale by OMRON.

OMRON MAKES NO WARRANTY OR REPRESENTATION, EXPRESS OR IMPLIED, REGARDING NON-INFRINGEMENT, MERCHANTABILITY, OR FITNESS FOR PARTICULAR PURPOSE OF THE PRODUCTS. ANY BUYER OR USER ACKNOWLEDGES THAT THE BUYER OR USER ALONE HAS DETERMINED THAT THE PRODUCTS WILL SUITABLY MEET THE REQUIREMENTS OF THEIR INTENDED USE. OMRON DISCLAIMS ALL OTHER WARRANTIES, EXPRESS OR IMPLIED.

### LIMITATIONS OF LIABILITY

OMRON SHALL NOT BE RESPONSIBLE FOR SPECIAL, INDIRECT, OR CONSEQUENTIAL DAMAGES, LOSS OF PROFITS OR COMMERCIAL LOSS IN ANY WAY CONNECTED WITH THE PRODUCTS, WHETHER SUCH CLAIM IS BASED ON CONTRACT, WARRANTY, NEGLIGENCE, OR STRICT LIABILITY.

In no event shall the responsibility of OMRON for any act exceed the individual price of the product on which liability is asserted.

IN NO EVENT SHALL OMRON BE RESPONSIBLE FOR WARRANTY, REPAIR, OR OTHER CLAIMS REGARDING THE PRODUCTS UNLESS OMRON'S ANALYSIS CONFIRMS THAT THE PRODUCTS WERE PROPERLY HANDLED, STORED, INSTALLED, AND MAINTAINED AND NOT SUBJECT TO CONTAMINATION, ABUSE, MISUSE, OR INAPPROPRIATE MODIFICATION OR REPAIR.

## Application Considerations

### SUITABILITY FOR USE

OMRON shall not be responsible for conformity with any standards, codes, or regulations that apply to the combination of products in the customer's application or use of the products.

Take all necessary steps to determine the suitability of the product for the systems, machines, and equipment with which it will be used.

Know and observe all prohibitions of use applicable to the products.

NEVER USE THE PRODUCTS FOR AN APPLICATION INVOLVING SERIOUS RISK TO LIFE OR PROPERTY WITHOUT ENSURING THAT THE SYSTEM AS A WHOLE HAS BEEN DESIGNED TO ADDRESS THE RISKS, AND THAT THE OMRON PRODUCTS ARE PROPERLY RATED AND INSTALLED FOR THE INTENDED USE WITHIN THE OVERALL EQUIPMENT OR SYSTEM.

### PROGRAMMABLE PRODUCTS

OMRON shall not be responsible for the user's programming of a programmable product, or any consequence thereof.

## Disclaimers

### CHANGE IN SPECIFICATIONS

Product specifications and accessories may be changed at any time based on improvements and other reasons. Consult with your OMRON representative at any time to confirm actual specifications of purchased products.

### DIMENSIONS AND WEIGHTS

Dimensions and weights are nominal and are not to be used for manufacturing purposes, even when tolerances are shown.

### PERFORMANCE DATA

Performance data given in this catalog is provided as a guide for the user in determining suitability and does not constitute a warranty. It may represent the result of OMRON's test conditions, and the users must correlate it to actual application requirements. Actual performance is subject to the OMRON Warranty and Limitations of Liability.